

mSATA Test Adapter

User Manual



**WILDER
TECHNOLOGIES**

It's all about integrity

Table of Contents

Introduction.....	3
Product Inspection	5
The mSATA Test Adapter Care and Handling Precautions	6
General Test Adapter, Cable, and Connector.....	8
Handling and Storage	8
Visual Inspection.....	8
Cleaning	8
Making Connections	8
Electrostatic Discharge Information.....	9
User Model	10
Calibration	12
SOLT.....	13
1X-THRU	14
Mechanical and Environmental Specifications.....	15
Electrical Specifications	20
Wilder Technologies, LLC – Limited Warranty	31
Wilder Technologies, LLC – Terms & Conditions of Sale	32
Compliance with Environmental Legislation	33
WEEE Compliance Statement.....	33
Glossary of Terms	34
Index	35

Introduction

This user's guide documents the mSATA Plug and Receptacle Test Adapters (mSATA-TPA-P and mSATA-TPA-R) and the associated Calibration Module. The two test adapter types, shown in Figures 1 and 2, test mSATA interface cables, hosts and devices against the SATA Specification 3.0. The Calibration Module, shown on Page 12, is used to zero-out test adapter attributes (using SOLT, with either the 1X-THRU or the 2X-THRU).

The TPA-P and TPA-R test adapter assemblies allow easy access, via SMA connections, to measure or inject Data signals. The Receptacle test adapter also provides input access to +1.5V, +3.3V, and their respective GNDs, via a 4-position input power connector. Or, the +3.3V and its respective GND can be connected via a 22-position SATA plug. Additionally, a 12-position low-speed connector is provided for access to commonly used low-speed signals. Mating 4-position and 12-position connector housings and contacts are provided to connect the above power supplies to a wiring assembly provided by the user. (A mating 22-position receptacle is NOT included with the mSATA-TPA-R.)

NOTE: To avoid damaging the cables, use the handling techniques described in the Care and Handling section before making any connections or configuring a test setup.

Always use a static-safe workstation when performing tests, as explained in the "Electrostatic Discharge Information" section.

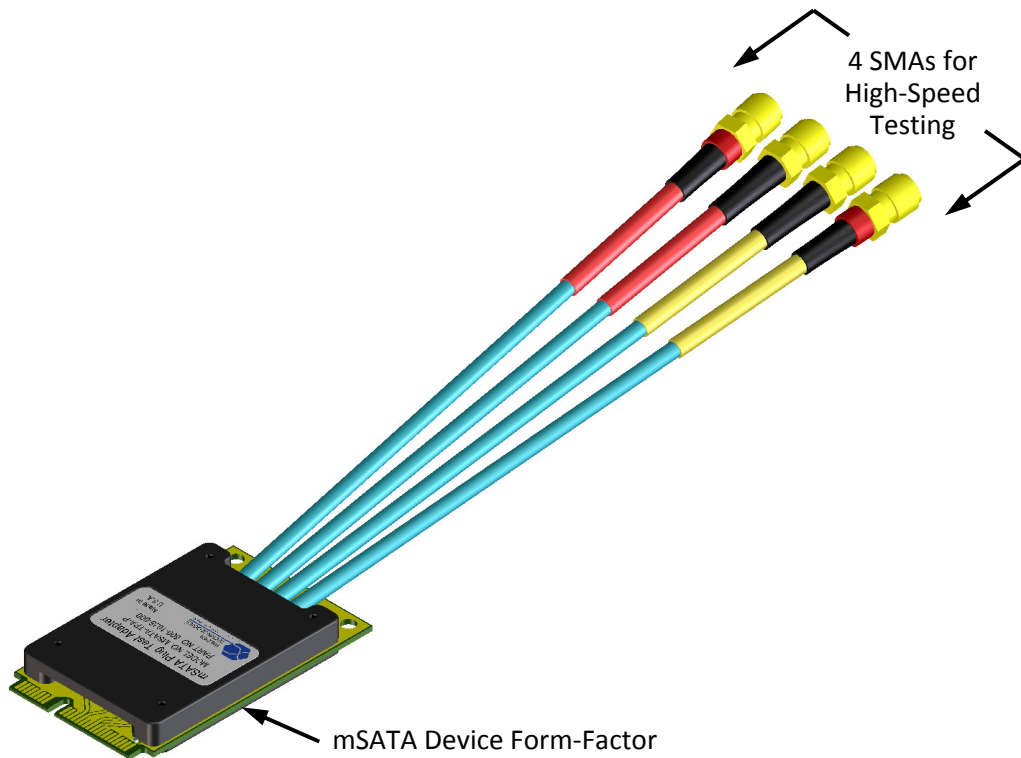

Figure 1. The mSATA Test Adapter (Plug)

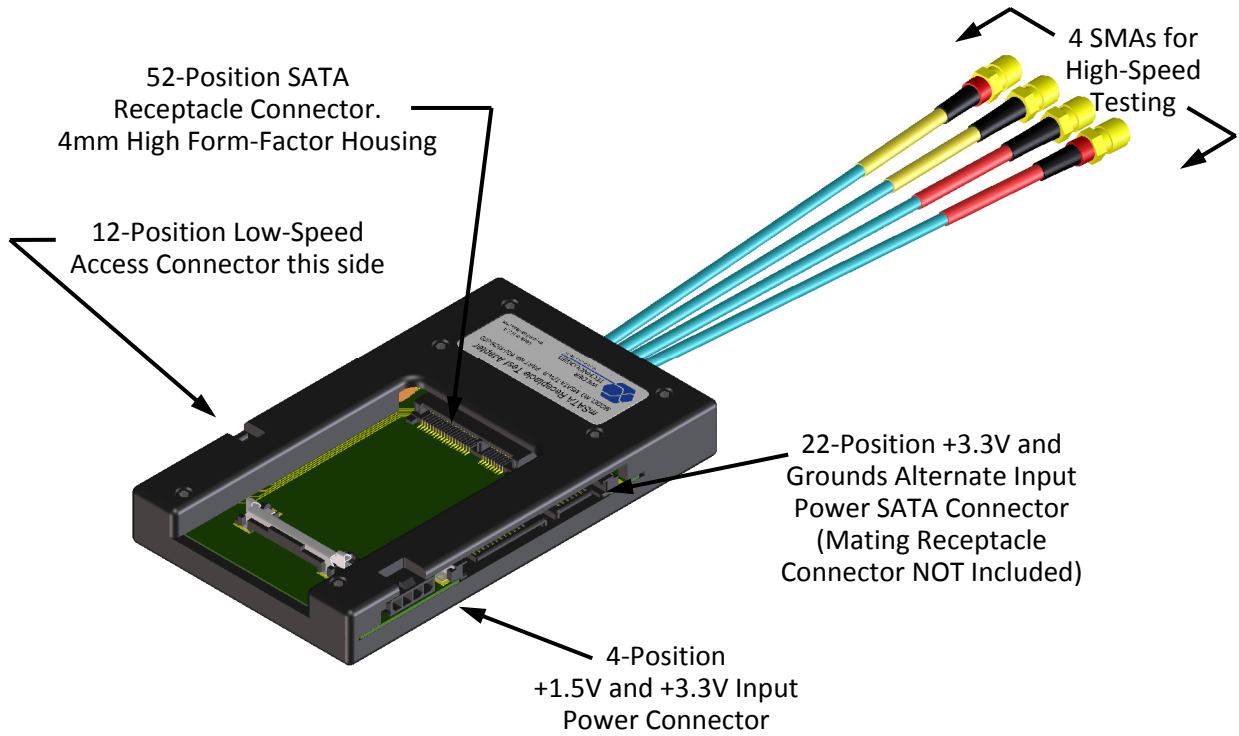

Figure 2. The mSATA Test Adapter (Receptacle)

The 4-position input power connector used in the receptacle test adapter is Molex part number 43650-0404. The 12-position low-speed connector is Molex part number 43650-1204. The mating receptacle connector housings and contact pins for 26-30awg wire are provided with each mSATA-TPA-R assembly (Molex part number 43645-0400 for the 4-position input power connector housing, 43645-1200 for the 12-position low-speed connector housing, and 43030-0011 for the 26-30awg pin contacts). Replacement receptacle housings or contacts can be purchased through Molex distributors.

Product Inspection

Upon receiving the mSATA-TPA from Wilder Technologies, perform the following product inspection:

- Inspect the outer shipping container, foam-lined instrument case, and product for damage. Retain the outer cardboard shipping container until the contents of the shipment have been inspected for completeness and the product has been checked mechanically and electrically. Use the foam-lined instrument-case for secure storage of the Wilder Technologies mSATA Test Adapter when not in use.
- Locate the shipping list and verify that all items ordered were received.
- In the unlikely event that the product is defective or incomplete, the “Limited Warranty” section discusses how to contact Wilder Technologies for technical assistance and/or how to package the product for return.

The mSATA Test Adapter Care and Handling Precautions

The mSATA Test Adapter requires careful handling to avoid damage. Improper handling techniques, or using too small a cable bend radius, can damage the coaxial cable connections within the adapter housing or the cables themselves. This can occur at any point along the cable. To achieve optimum performance and to prolong the mSATA-TPA's life, observe the following handling precautions:

- **CAUTION 1: Avoid Torque Forces (Twisting)**
While individual coaxial cables within the test adapter have some rotational freedom, twisting the mSATA-TPA as a unit, with one end held stationary, may damage or severely degrade performance. Adherence to Caution 5 (below) helps to avoid twisting.
- **CAUTION 2: Avoid Sharp Cable Bends**
Never bend coaxial cables into a radius of 26 mm (1-inch) or less. Never bend cables greater than 90°. Single or multiple cable bends must be kept within this limit. Bending the mSATA-TPA cables less than a 26mm (1-Inch) radius will permanently damage or severely degrade test adapter performance.
- **CAUTION 3: Avoid Cable Tension (Pull Forces)**
Never apply tension (pull forces) to an individual coaxial cable that is greater than 2.3 kg (5 lbs.). To avoid applying tension, always place accessories and equipment on a surface that allows adjustment to eliminate tension on the mSATA-TPA and cables. Use Disk Drive mounting brackets or rails, adjustable elevation stands or apparatus to accurately place and support the mSATA-TPA.
- **CAUTION 4: Connect the mSATA-TPA First**
To prevent twisting, bending, or applying tension to the coaxial cables when connecting a mSATA-TPA, always attach the mSATA-TPA to the device under test (DUT) or cable under test before attaching any SMA connectors. Carefully align the mSATA connectors and then gently push the connectors together until fully seated.

If the mSATA-TPA must be turned or twisted to make connection to the DUT, avoid using the mSATA-TPA housing alone to make this occur. Try to distribute the torque forces along the length of the test setup and cabling. If this is not possible, it is recommended to first loosen or disconnect the SMA connections at the mSATA-TPA, make the connection to the DUT and then re-tighten or attach the test equipment leads.

NOTE: Only grip the test adapter housing when inserting or extracting the mSATA-TPA to or from the DUT. Pulling directly on the mSATA-TPA cables or using them to insert the mSATA-TPA may cause damage.

- **CAUTION 5: Carefully Make SMA Connections**
To connect the mSATA-TPA SMA connectors, follow these steps:
 1. Hold the cable stationary by grasping the cable at the black heat-shrink section near the SMA connector.

2. Insert the mating SMA barrel and hand-tighten the free-spinning SMA nut onto the connector while avoiding pulling, bending, or twisting the mSATA-TPA coaxial cable.
3. The mSATA-TPA SMA connectors have flats that accept an open-end 1/4-inch or 6.5mm wrench. When attaching instrument cables to the mSATA-TPA, it is recommended that the mSATA-TPA SMA connectors be mechanically held and the test leads be tightened to the equipment manufacturer's torque recommendations, normally 5 in-lbs, using a 5/16-inch open-end wrench.

If the test set-up requires repositioning, first loosen or disconnect the SMA connections to avoid twisting, bending, or tension.

NOTE: A drop in signal amplitude by half or 6db during the testing of a channel may indicate that a cable has been mechanically pulled free of coaxial cable connections internal to the assembly. This could be determined by checking if the cable has any lateral play relative to the TPA. This would only occur when the TPA has exceeded the pull force as specified within the mechanical specification. If the cable cannot be re-seated, the test adapter will need to be sent back to the factory for service.

- **CAUTION 6: Independently Support Instrument Cables or Accessories**
Excessive weight from instrument cables and/or accessories connected to the mSATA-TPA can cause damage or affect the test adapter performance. Be sure to provide appropriate means to support and stabilize all test set-up components.

General Test Adapter, Cable, and Connector

Observing simple precautions can ensure accurate and reliable measurements.

Handling and Storage

Before each use of the mSATA-TPA, ensure that all connectors are clean. Handle all cables carefully and store the mSATA-TPA in the foam-lined instrument case when not in use, if possible. Do not set connectors contact end down. Install the SMA protective end caps when the mSATA-TPA is not in use.

Visual Inspection

Be sure to inspect all cables carefully before making a connection. Inspect all cables for metal particles, scratches, deformed threads, dents, or bent, broken, or misaligned center conductors. Do not use damaged cables.

Cleaning

If necessary, clean the connectors using low-pressure (less than 60 PSI) compressed air or nitrogen with an effective oil-vapor filter and condensation trap. Clean the cable threads, if necessary, using a lint-free swab or cleaning cloth moistened with isopropyl alcohol. Always completely dry a connector before use. Do not use abrasives to clean the connectors. Re-inspect connectors, making sure no particles or residue remains.

Making Connections

Before making any connections, review the “Care and Handling Precautions” section. Follow these guidelines when making connections:

- Align cables carefully
- Make preliminary connection lightly
- To tighten, turn connector nut only
- Do not apply bending force to cable
- Do not over-tighten preliminary connections
- Do not twist or screw-in cables
- Use a torque wrench, and do not tighten past the “break” point of the torque wrench

Electrostatic Discharge Information

Protection against electrostatic discharge (ESD) is essential while connecting, inspecting, or cleaning the mSATA-TPA test adapter and connectors attached to a static-sensitive circuit (such as those found in test sets).

Electrostatic discharge can damage or destroy electronic components. Be sure to perform all work on electronic assemblies at a static-safe work station, using two types of ESD protection:

- Conductive table-mat and wrist-strap combination
- Conductive floor-mat and heel-strap combination

When used together, both of these types provide a significant level of ESD protection. Used alone, the table-mat and wrist-strap combination provide adequate ESD protection. To ensure user safety, the static-safe accessories must provide at least 1 M Ω of isolation from ground. Acceptable ESD accessories may be purchased from a local supplier.

WARNING: These techniques for a static-safe work station should not be used when working on circuitry with a voltage potential greater than 500 volts.

User Model

The mSATA TPA supports all testing of the SATA Specification. It is capable of performing well beyond the scope of measurements required, limited only by the specifications, environmental, care and handling as stated in this document.

The following examples are suggestions for possible testing setups.

In this first example, an mSATA receptacle TPA is used to test an mSATA device:

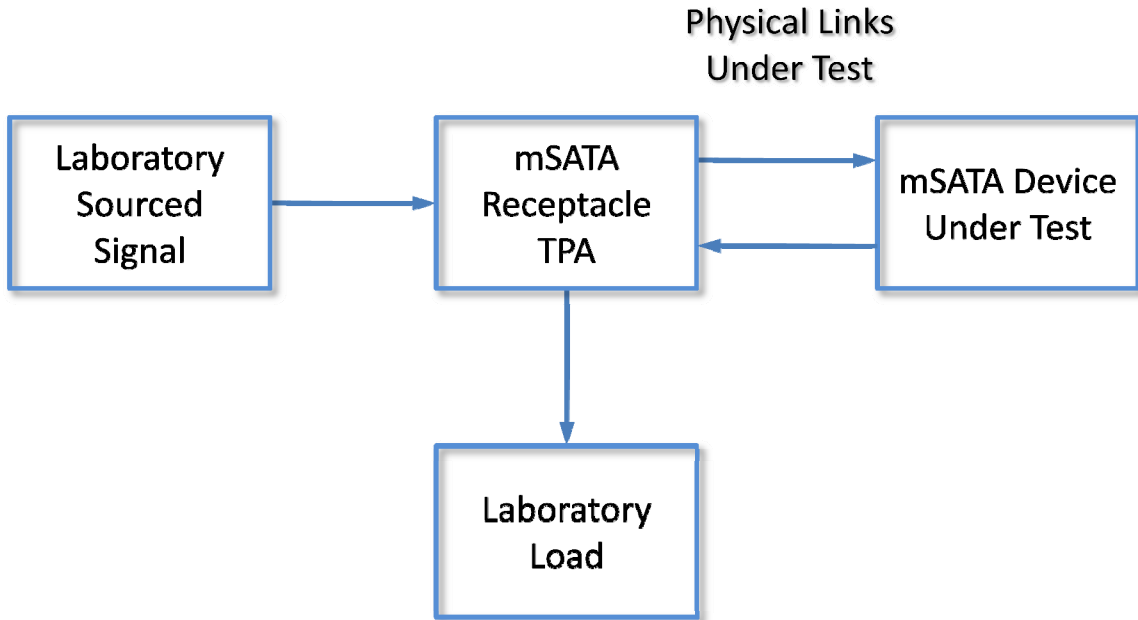

The second example shows an mSATA Plug TPA used to test a host:

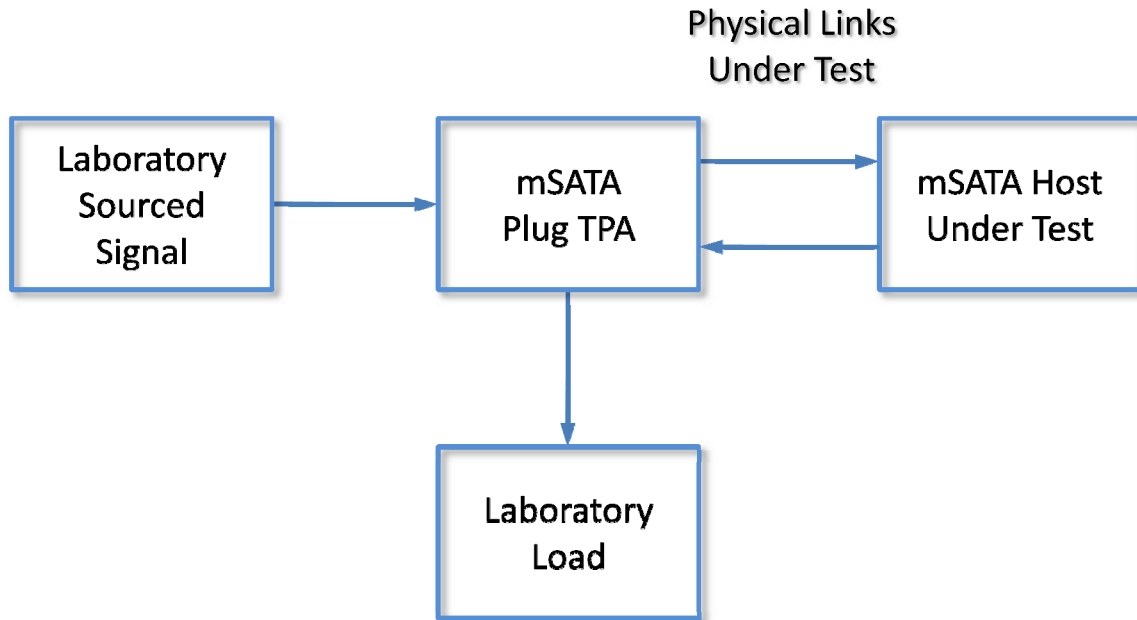

Calibration

The mSATA Plug and Receptacle Test Adapters are passive components. Therefore, calibration for the errors generated must occur within the test instrumentation that drives the mSATA target device or looks at the response of the mSATA initiator device.

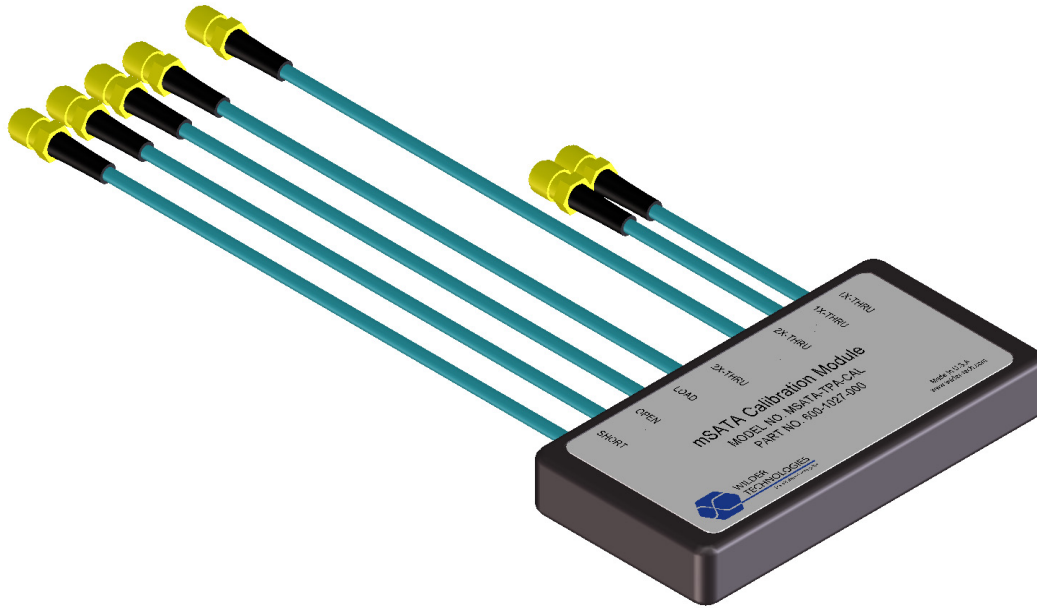

Figure 3. Calibration module (mSATA-TPA-C) showing standard 6-inch cable on SOLT and 3-inch cables connected to the 1X-THRU

SOLT

SHORT, OPEN, LOAD, and 2X-THRU (SOLT) are calibration standards used to compensate for errors associated with the TPA when used for Jitter measurement, TDR, TDT, and VNA testing. SOLT represents the same electrical length and losses as the TPA through the mSATA connector pad, and enables the test engineer to compensate for the following six repeatable, systematic errors that occur when moving the reference plane:

- Signal leakage effects: *Directivity errors*
- Signal leakage effects: *Crosstalk errors*
- Reflection effects: *Source Impedance Mismatching errors*
- Reflection effects: *Load Impedance Mismatching errors*
- Bandwidth effects: *Receiver Transmission in Test Equipment errors*
- Bandwidth effects: *Receiver Reflection-tracking in Test Equipment errors*

These errors need to be corrected on each port. Refer to the Instrument Manual for instructions on the instrument's specific calibration process.

NOTE: The reference plane is the boundary, both physically and electrically, between the calibrated and uncalibrated portions of the circuit. Everything outside the reference plane is considered part of the DUT. Any instrument that does not use calibration defines the DUT as the total of externally connected components. If the mSATA-TPA-C is not used, all of the mSATA-TPA and the 6-inch cables, as well as cables connecting the 6-inch cables to the test instrument, would be a part of the DUT.

Non-repeatable errors, such as drift or random errors, can be reduced but not corrected. Drift errors aggregate over time or with environmental changes such as temperature shift. To eliminate drift errors, perform another calibration.

A random error cannot be corrected through calibration since the error occurred randomly. Random errors are typically associated with either test instrument noise or test repeatability problems. Reduce test instrument noise by increasing source power, lowering the IF bandwidth, or averaging results over multiple sweeps. Reduce test repeatability problems through the use of a torque wrench or, again, by averaging over multiple sweeps.

1X-THRU

The 1X-THRU is a calibration feature used to calibrate time domain instrumentation (for example, pre-emphasized pulse generators or AWGs, arbitrary waveform generators). 1X-THRU calibration compensates two error sources – cable losses and group delay:

- **Cable Losses** – Cable losses associated with the mSATA plug TPA, and its respective cabling that's connected to the test source, consist of skin loss and, to a lesser extent, dielectric loss. Pre-emphasis or de-emphasis is used at the signal source to correct for these cable losses. Pre-emphasis is a boost of the signal level just after an edge transition; de-emphasis is a reduction in the low-speed amplitude of the signal source. Typically, on a de-emphasized signal the levels have to be reset to attain the same output levels. Resultant signals from either pre-emphasis or de-emphasis are identical relative to the DUT.

For the purposes of this discussion, pre-emphasis will be used. To set the pre-emphasis, first determine the amount of signal boost by connecting the signal source, via the 1X-THRU and the respective cable used to connect the DUT to the source to a high-speed oscilloscope or a jitter measurement device. Trigger the oscilloscope or jitter measurement device using a trigger from the source. The trigger, a single event, indicates the start of the signal being sent to the DUT. Adjust pre-emphasis to maximize the eye opening.

- **Group Delay** – Group delay is the second error source for 1X-THRU calibration. When the DUT generates an output signal, it can be used to measure delay. To create a baseline delay measurement, connect the output signal cable to the input signal cable and the 1X-THRU. To determine corrected DUT delay, subtract this baseline measurement from the DUT delay measurements.

Mechanical and Environmental Specifications

NOTE: All specifications in this manual are subject to change.

Table 1. General Specifications

ITEM	DESCRIPTION
Usage Environment	Controlled indoor environment
Plug Test Adapter Length (w/ std. cables)	168 mm +/- 2 mm (6.61 inches +/- .08 inches) (Characteristic)
Receptacle Test Adapter Length (w/std. cables)	238.3 mm +/- 2 mm (9.38 inches +/- .08 inches) (Characteristic)
Operating Temperature	0°C to +55°C (32°F to +131°F) (Characteristic)
Storage Temperature	-40°C to +70°C (-40°F to +158°F) (Characteristic)

mSATA-TPA-R Cable Pinout

The mSATA-TPA-R cables provide four SMA connectors (one lane of primary differential TX and RX), one 4-position input power connector, one 22-position SATA plug as an alternate input power connector, and one 12-position connector containing the low speed signals. Labels clearly mark each cable or connector. The following figure refers to pin-description tables for each of the three connector types. Note: The power supplies each have 22 μ F in parallel with several 0.01 μ F capacitors.

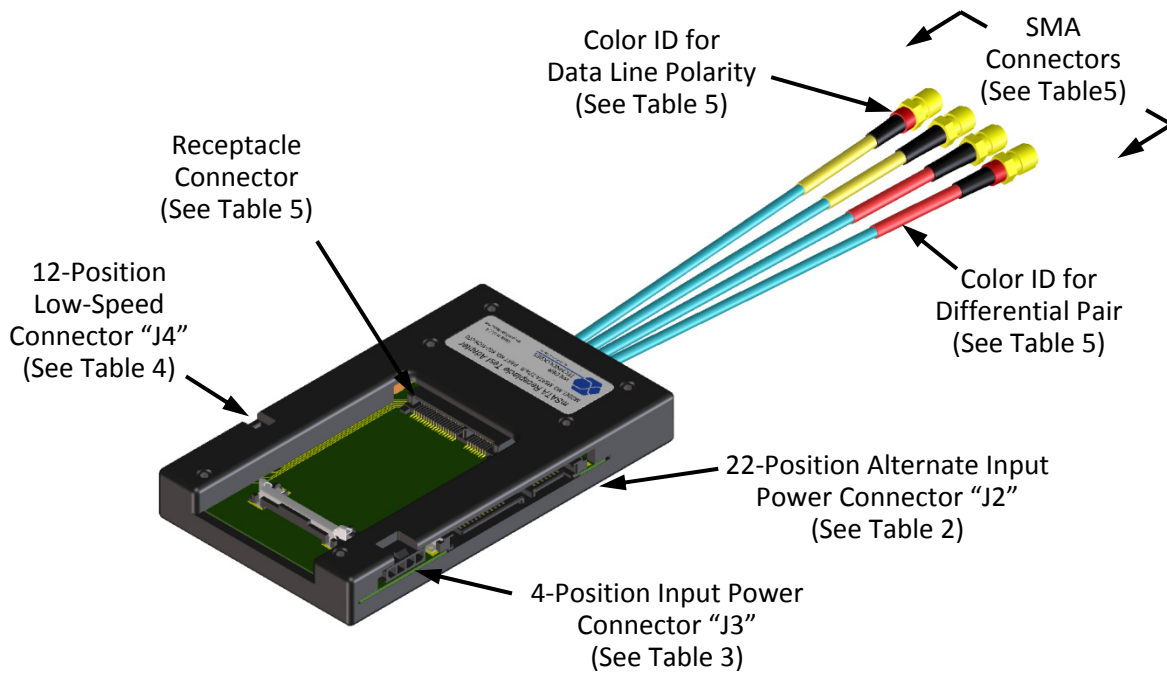

Figure 4. Cable Connectors (mSATA-TPA-R shown)

Table 2. mSATA-TPA-R SATA 22-Position Alternate +3.3V Input Power Connector “J2”

LABEL	PIN NO.	DESCRIPTION
Unmarked	S1, S4, S7	Ground
Unmarked	S2, S3, S5, S6	No connect
Unmarked	P1, P2, P3	+3.3Volts
Unmarked	P4, P5, P6, P10, P12	Ground
Unmarked	P7, P8, P9, P11, P13, P14, P15	No connect

Table 3. mSATA-TPA-R 4-Position Input Power Connector “J3”

LABEL	PIN NO.	DESCRIPTION
+1.5V	Pin 1	+1.5 Volts
GND	Pin 2	Ground
GND	Pin 3	Ground
+3.3V	Pin 4	+3.3 Volts

Table 4. mSATA-TPA-R 12-Position Low-Speed Connector “J4”

LABEL	PIN NO.	DESCRIPTION
GND	Pin 1	Ground
TWIDAT	Pin 2	Two wire Interface Data
TWICKL	Pin 3	Two Wire Interface Clock
MFGP45	Pin 4	Vendor Specific / Manufacturing Pin 45
MFGP47	Pin 5	Vendor Specific / Manufacturing Pin 47
DA/DSS	Pin 6	Device Activity Signal / Disable Staggered Spin-Up
PREDET	Pin 7	Presence Detection
USER-1	Pin 8	For User Connection
USER-2	Pin 9	For User Connection
USER-3	Pin 10	For User Connection
USER-4	Pin 11	For User Connection
USER-5	Pin 12	For User Connection

mSATA Test Adapter User Manual

Table 5. mSATA Receptacle Pin Assignments

Pin Description	Connector Pin Number	Destination Number	Color ID for Data Line Polarity	Color ID for Differential Pair (Receptacle)
Reserved	P1, P3, P5, P7, P8, P10, P11, P12, P13, P14, P16, P17, P19, P20, P22, P36, P38, P42, P44, P46	No Connect	N/A	N/A
+3.3 Volts	P2, P24, P39, P41, P52	+3.3V	N/A	N/A
Ground	P4, P9, P15, P18, P21, P26, P27, P29, P34, P35, P37, P40, P43, P50	GND	N/A	N/A
+1.5 Volts	P6, P28, P48	+1.5V	N/A	N/A
Drive Primary Transmitter Positive	P23	DRIVE TP+	Red	Red Label
Drive Primary Transmitter Negative	P25	DRIVE TP-	Black	Red Label
Two Wire Interface Clock	P30	TWICKL	N/A	N/A
Drive Primary Receiver Negative	P31	DRIVE RP-	Black	Yellow Label
Two Wire Interface Data	P32	TWIDAT	N/A	N/A
Drive Primary Receiver Positive	P33	DRIVE RP+	Red	Yellow Label
Vendor Specific / Manufacturing Pin	P45	MFGP45	N/A	N/A
Vendor Specific / Manufacturing Pin	P47	MFGP47	N/A	N/A
Device Activity Signal / Disable Staggered Spin-Up	P49	DA/DSS	N/A	N/A
Presence Detection	P51	PREDET	N/A	N/A
Optional User Access	N/A	USER-1	N/A	N/A
Optional User Access	N/A	USER-2	N/A	N/A
Optional User Access	N/A	USER-3	N/A	N/A
Optional User Access	N/A	USER-4	N/A	N/A
Optional User Access	N/A	USER-5	N/A	N/A

mSATA-TPA-P Cable Pinout

The mSATA-TPA-P cables provide four SMA connectors (one lane of primary differential TX and RX). Labels clearly mark each cable or connector. The following figure refers to the pin-description table for the plug connector.

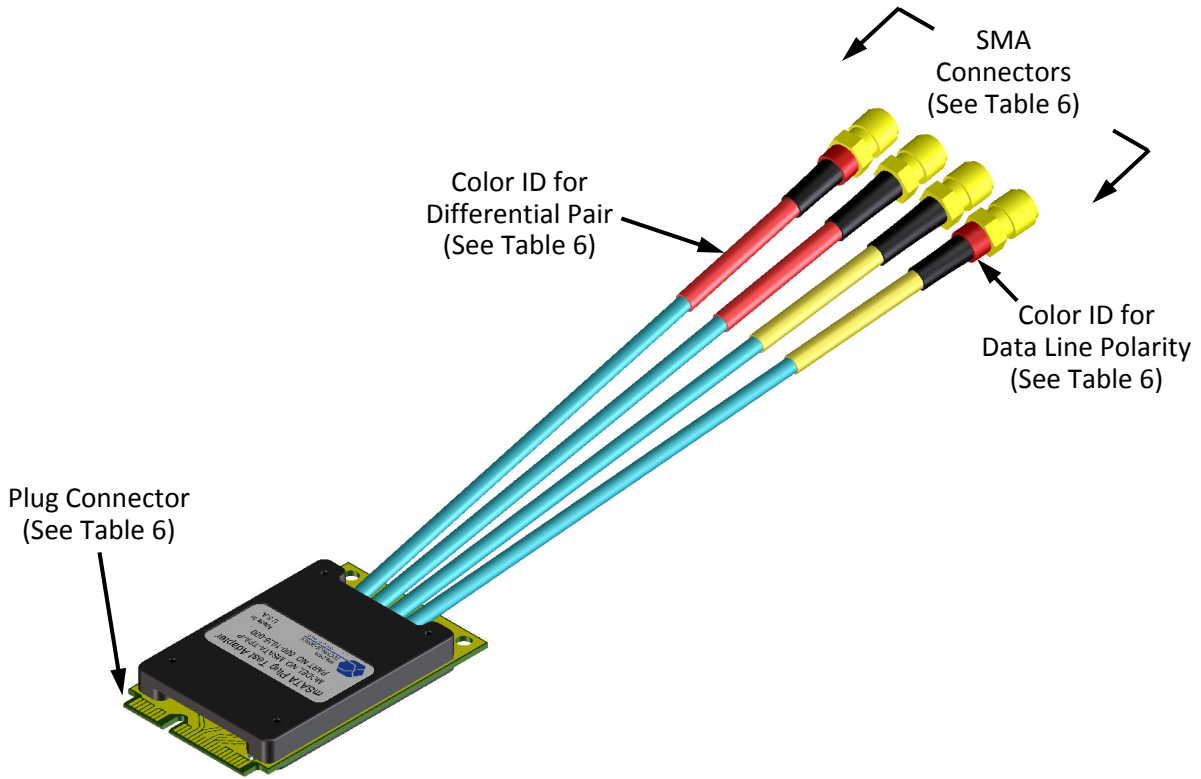



Figure 5. Cable Connectors (mSATA-TPA-P shown)

Table 6. mSATA Plug Pin Assignments

Pin Description	Connector Pin Number	Destination Number	Color ID for Data Line Polarity	Color ID for Differential Pair (Plug)
Reserved	P1, P3, P5, P7, P8, P10, P11, P12, P13, P14, P16, P17, P19, P20, P22, P36, P38, P42, P44, P46	No Connect	N/A	N/A
+3.3 Volts	P2, P24, P39, P41, P52	No Connect	N/A	N/A
Ground	P4, P9, P15, P18, P21, P26, P27, P29, P34, P35, P37, P40, P43, P50	GND	N/A	N/A
+1.5 Volts	P6, P28, P48	No Connect	N/A	N/A
Host Primary Receiver Positive	P23	HOST RP+	Red	Red Label
Host Primary Receiver Negative	P25	HOST RP-	Black	Red Label
Two Wire Interface Clock	P30	No Connect	N/A	N/A
Host Primary Transmitter Negative	P31	HOST TP-	Black	Yellow Label
Two Wire Interface Data	P32	No Connect	N/A	N/A
Host Primary Transmitter Positive	P33	HOST TP+	Red	Yellow Label
Vendor Specific / Manufacturing Pin	P45, P47	No Connect	N/A	N/A
Device Activity Signal / Disable Staggered Spin-Up	P49	No Connect	N/A	N/A
Presence Detection	P51	1K Ohm to GND	N/A	N/A



Electrical Specifications

NOTE: All specifications in this manual are subject to change.

Table 7. Electrical Specifications

SPECIFICATION	MINIMUM	TYPICAL	MAXIMUM	NOTES
Insertion Loss (GHz), at -3 db	14	18.5		2X-THRU with six-inch cables
Return Loss (GHz), at -20 db	10	13		2X-THRU with six-inch cables
Insertion Loss (GHz), at -3 db		26.5		1X-THRU with three-inch cables
Return Loss (GHz), at -20 db		8.5		1X-THRU with three-inch cables
VSWR, at 10 GHz	1.21:1			2X-THRU with six-inch cables
Differential Impedance (ohms), 100 ps Rise Time	95		105	All Differential Pairs, Receptacle and Plug, excluding mSATA connector.
Differential Impedance (ohms), 100 ps Rise Time	90		110	All Differential Pairs, Receptacle and Plug, including mSATA connector.
Impedance (ohms), 100 ps Rise Time	47.5		52.5	All Differential Pairs, Receptacle and Plug, excluding mSATA connector.
Impedance (ohms), 100 ps Rise Time	47.5		52.5	SHORT, OPEN, LOAD, 1X-THRU, and 2X-THRU
Intra-pair Skew (ps)	-6		6	All Differential Pairs, Receptacle and Plug
Inter-pair Skew (ps)	-6		6	All Differential Pairs, Receptacle and Plug
NEXT (db), at 4.5 GHz	-40			All differential pairs, single aggressor, without mSATA connector, with six-inch cables and terminations
Current Carrying (A)	1.0			+3.3V Power
Current Carrying (A)	0.5			+1.5V Power

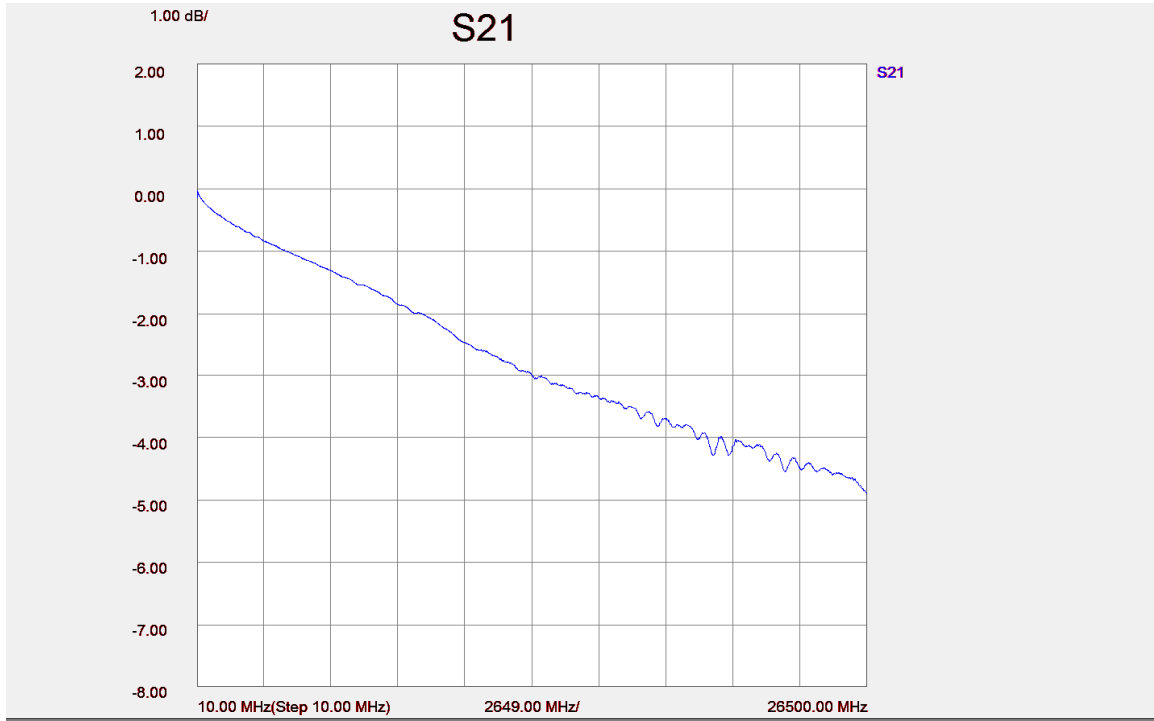

Figure 6. Typical 2X-THRU insertion loss

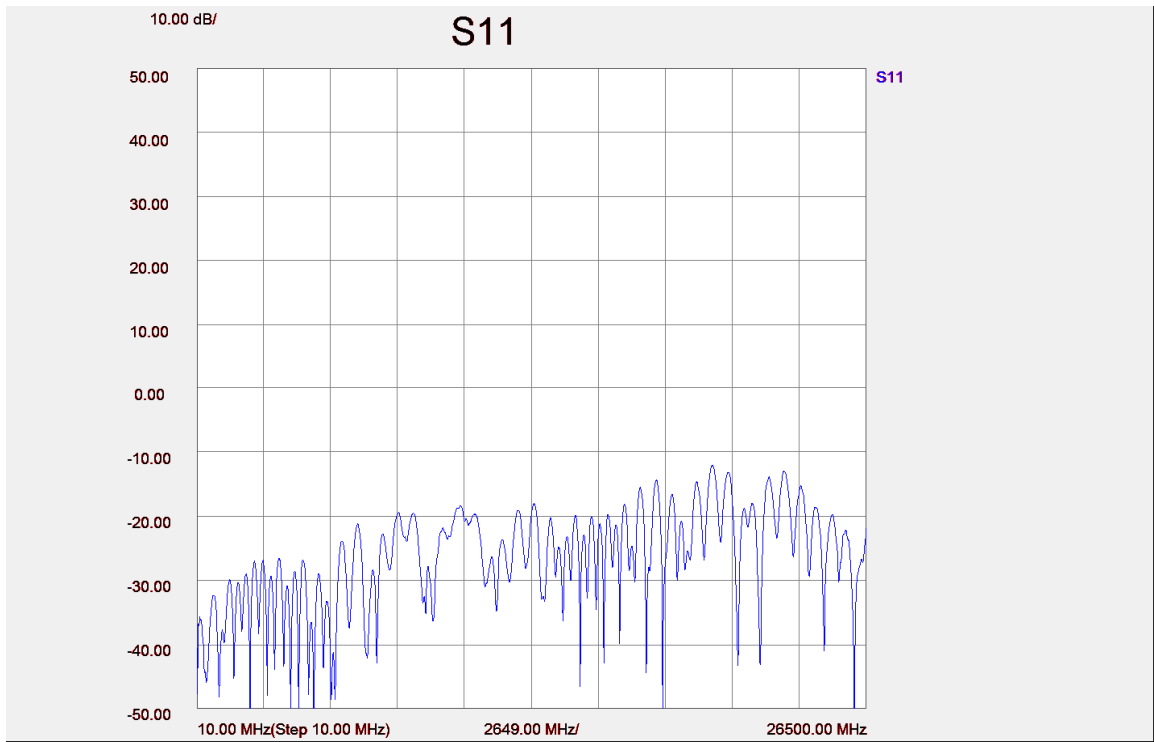

Figure 7. Typical 2X-THRU return loss

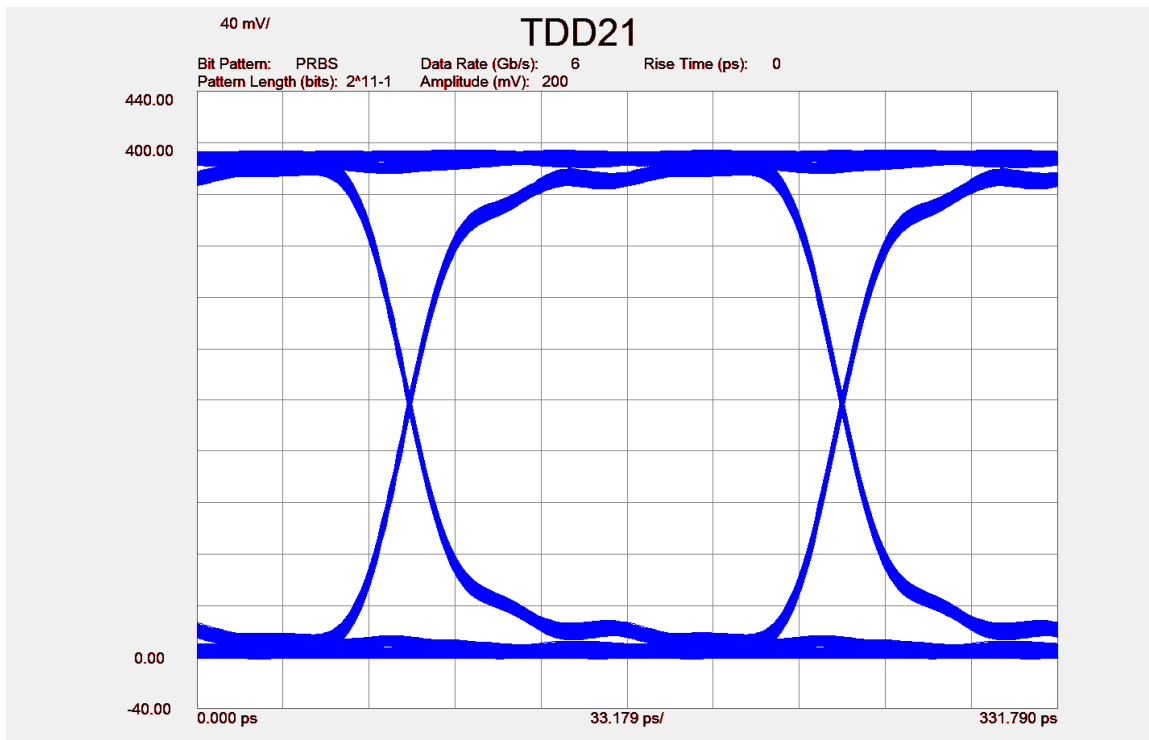
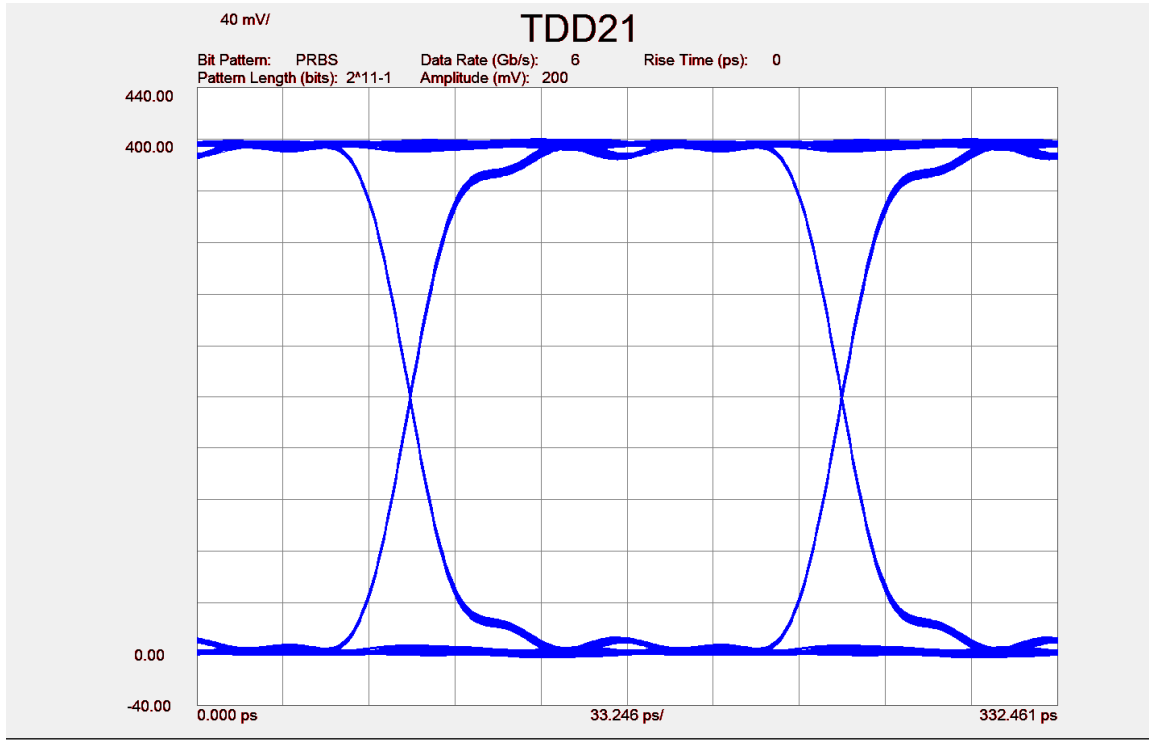

Figure 8. Typical mated pair 6 Gb/s eye diagram, with calibration (top) and without calibration (bottom)

Parameter Measurement Result

Name	Measurement Result
Eye Level Zero(mV)	3.77
Eye Level One(mV)	394.23
Eye Level Mean(mV)	199.00
Eye Amplitude(mV)	390.46
Eye Height(mV)	372.34
Eye Height(db)	-4.29
Eye Width	1.65e-010
Eye Opening Factor	0.95
Eye Signal_to_Noise	58.00
Eye Duty Cycle Dist	1.55e-016
Eye Duty Cycle Dist(%)	0.00
Eye Rise Time (20-80)	2.29e-011
Eye Fall Time (80-20)	2.29e-011
Eye Jitter(PP)	1.85e-012
Eye Jitter(RMS)	3.26e-013

S_n Param DUT Files Meas

Parameter Measurement Result

Name	Measurement Result
Eye Level Zero(mV)	11.86
Eye Level One(mV)	381.52
Eye Level Mean(mV)	196.69
Eye Amplitude(mV)	369.67
Eye Height(mV)	336.45
Eye Height(db)	-4.73
Eye Width	1.64e-010
Eye Opening Factor	0.91
Eye Signal_to_Noise	23.39
Eye Duty Cycle Dist	9.91e-016
Eye Duty Cycle Dist(%)	0.00
Eye Rise Time (20-80)	2.67e-011
Eye Fall Time (80-20)	2.67e-011
Eye Jitter(PP)	2.59e-012
Eye Jitter(RMS)	6.32e-013

S_n Param DUT Files Meas

Figure 9. Typical mated pair 6 Gb/s eye data, with calibration (top) and without calibration (bottom)

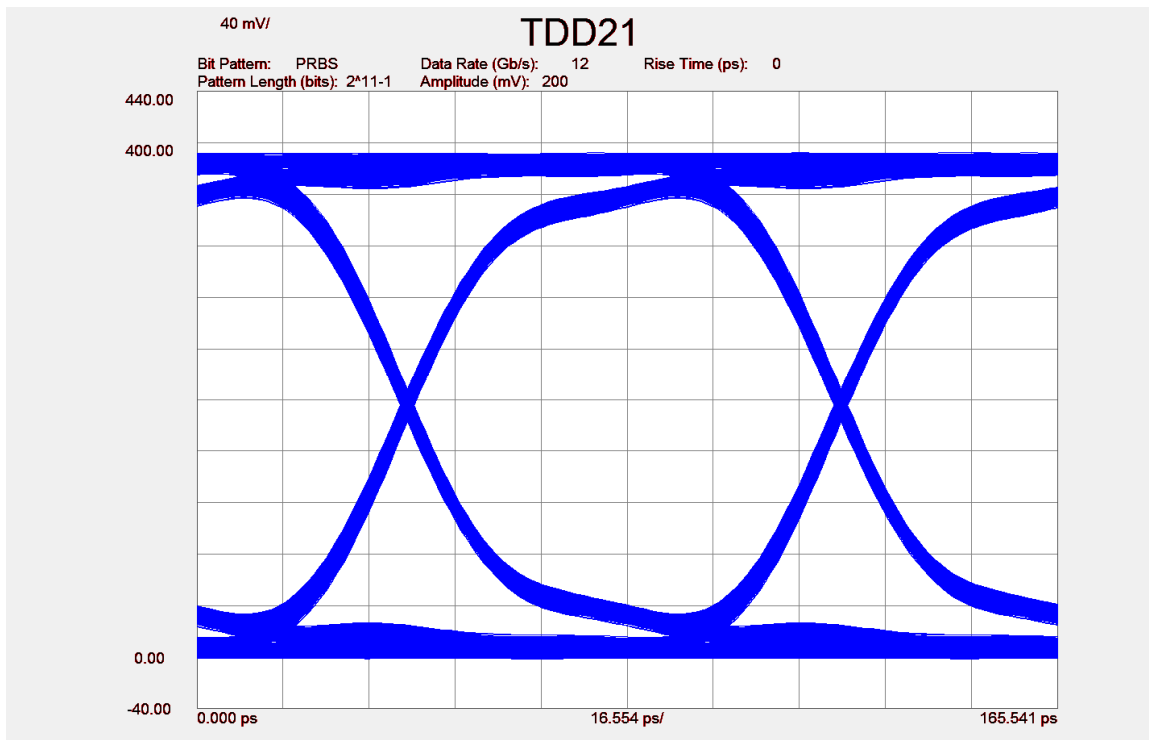
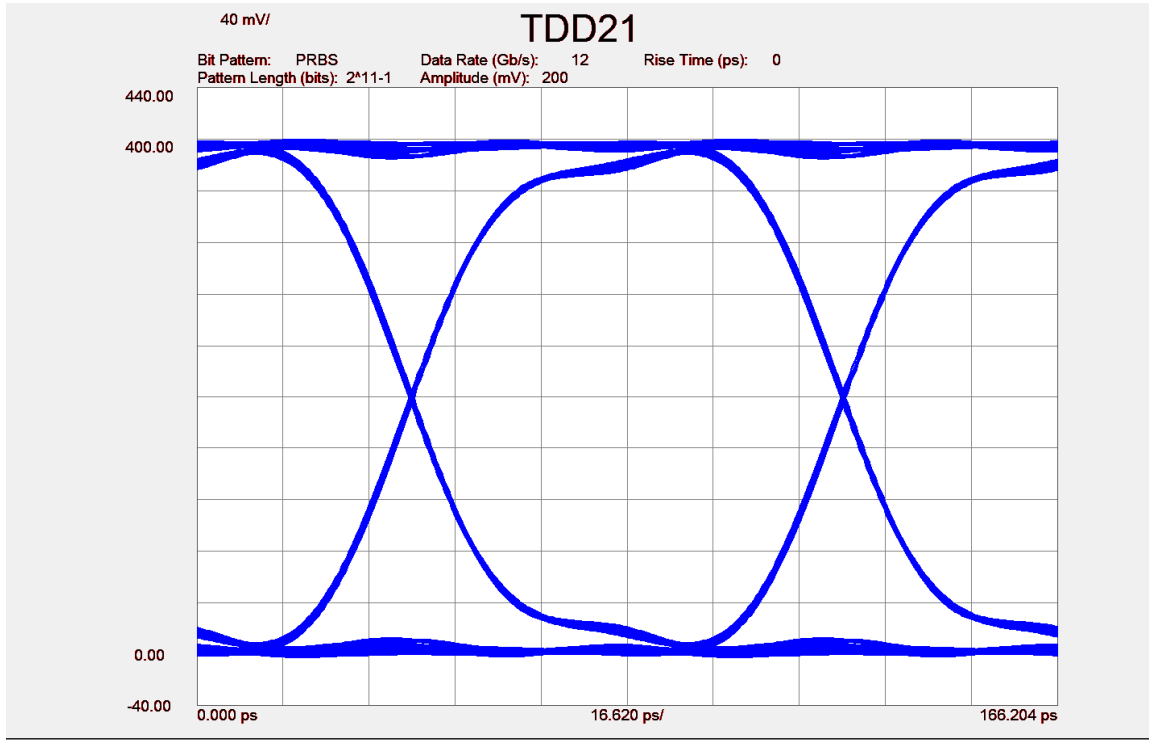

Figure 10. Typical mated pair 12 Gb/s eye diagram, with calibration (top) and without calibration (bottom)

Parameter Measurement Result

Name	Measurement Result
Eye Level Zero(mV)	9.57
Eye Level One(mV)	388.15
Eye Level Mean(mV)	198.86
Eye Amplitude(mV)	378.58
Eye Height(mV)	339.44
Eye Height(db)	-4.69
Eye Width	8.13e-011
Eye Opening Factor	0.90
Eye Signal_to_Noise	21.93
Eye Duty Cycle Dist	-2.27e-014
Eye Duty Cycle Dist(%)	-0.03
Eye Rise Time (20-80)	2.24e-011
Eye Fall Time (80-20)	2.24e-011
Eye Jitter(PP)	2.03e-012
Eye Jitter(RMS)	4.76e-013

S_n Param DUT Files Meas

Parameter Measurement Result

Name	Measurement Result
Eye Level Zero(mV)	20.98
Eye Level One(mV)	371.03
Eye Level Mean(mV)	196.01
Eye Amplitude(mV)	350.05
Eye Height(mV)	291.59
Eye Height(db)	-5.35
Eye Width	7.98e-011
Eye Opening Factor	0.83
Eye Signal_to_Noise	12.54
Eye Duty Cycle Dist	-4.35e-014
Eye Duty Cycle Dist(%)	-0.05
Eye Rise Time (20-80)	2.50e-011
Eye Fall Time (80-20)	2.50e-011
Eye Jitter(PP)	3.51e-012
Eye Jitter(RMS)	8.16e-013

S_n Param DUT Files Meas

Figure 11. Typical mated pair 12 Gb/s eye data, with calibration (top) and without calibration (bottom)

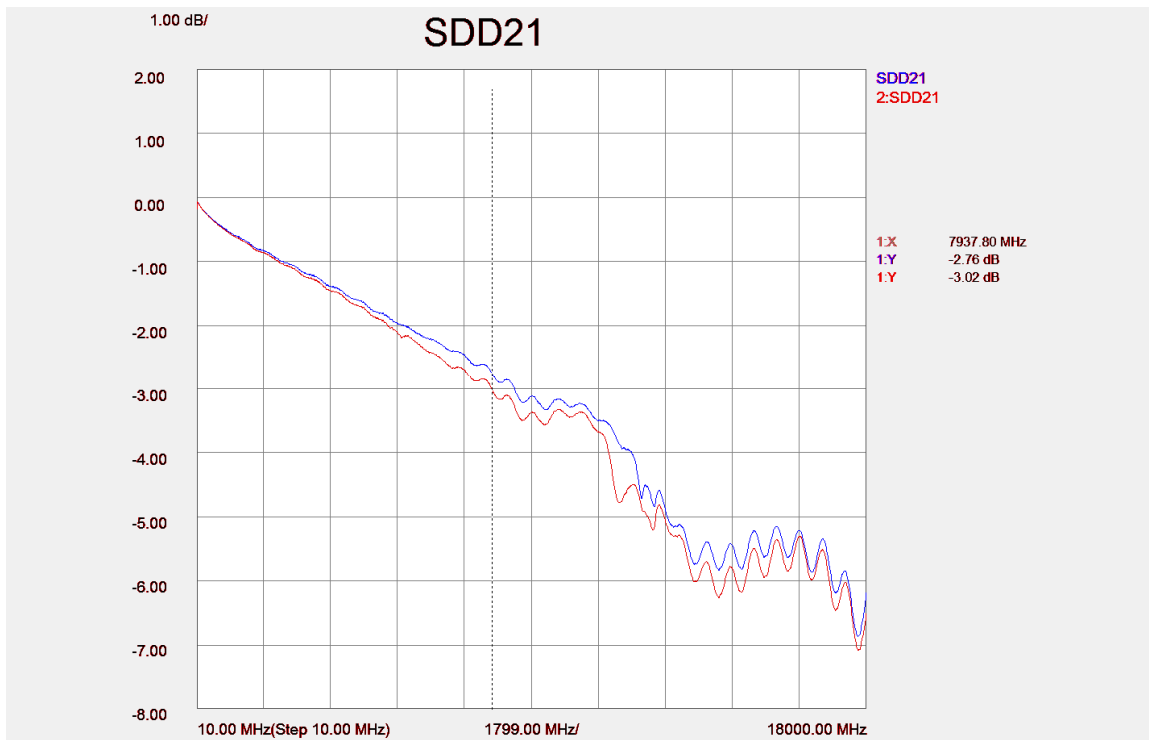
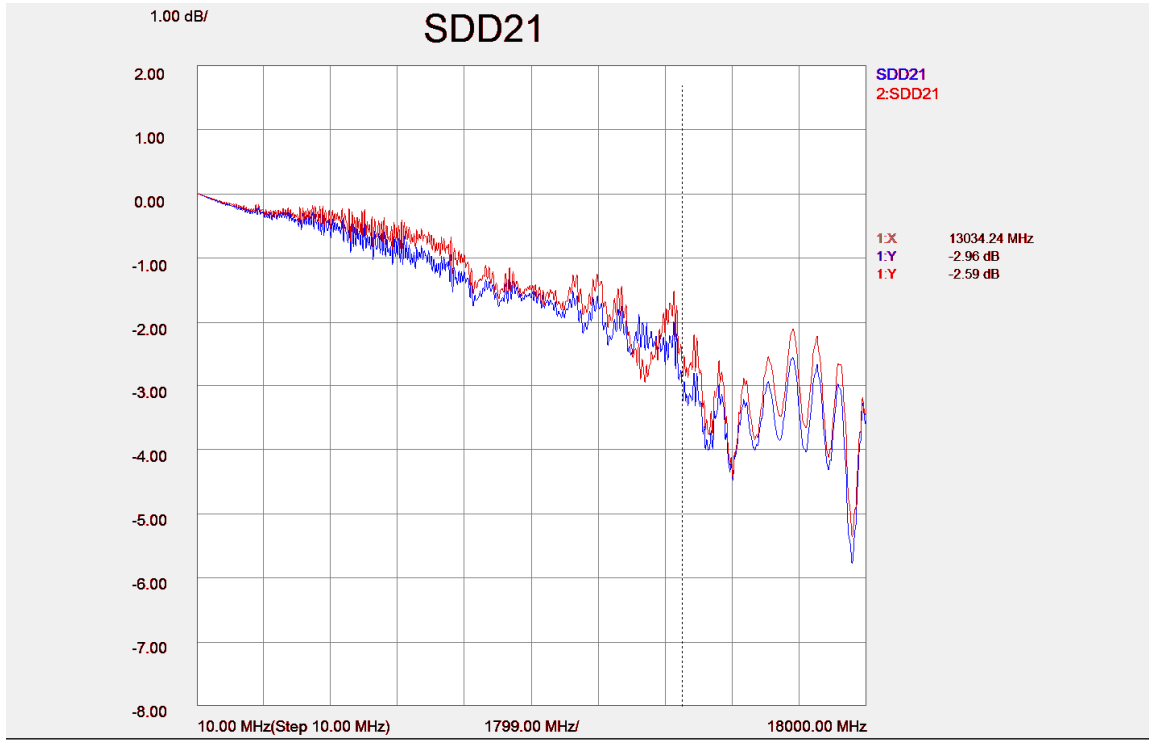

Figure 12. Typical mated pair balanced insertion loss, with calibration (top) and without calibration (bottom)

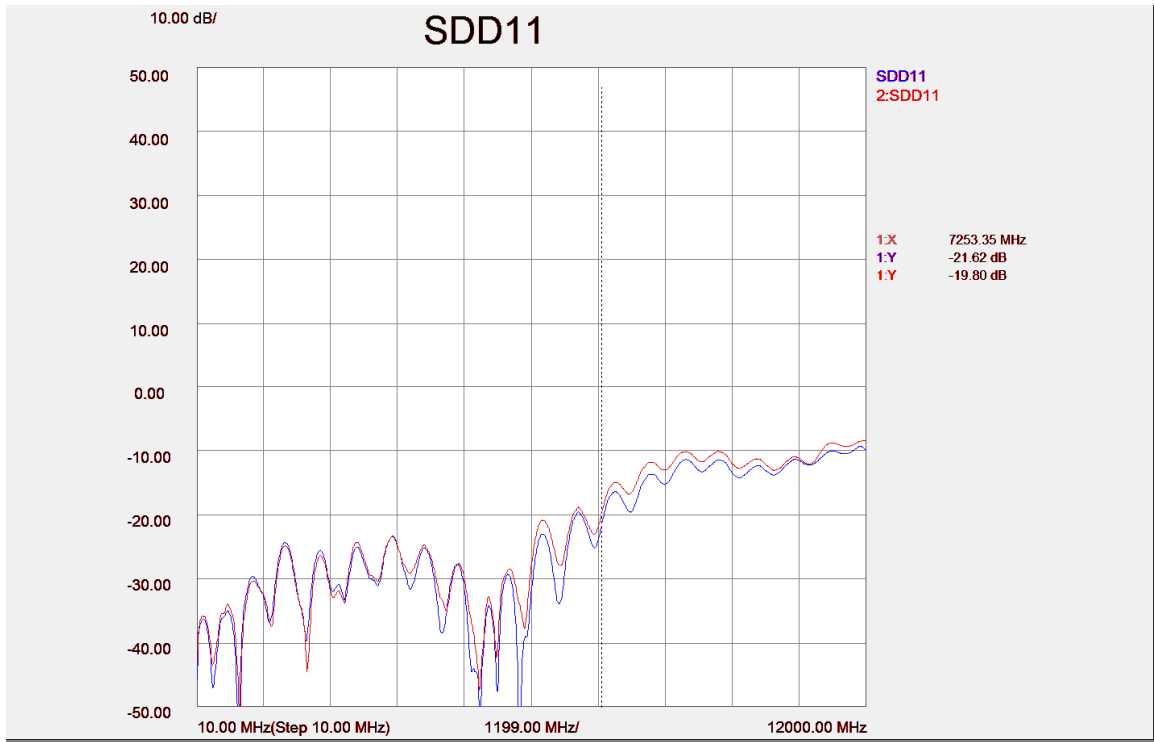
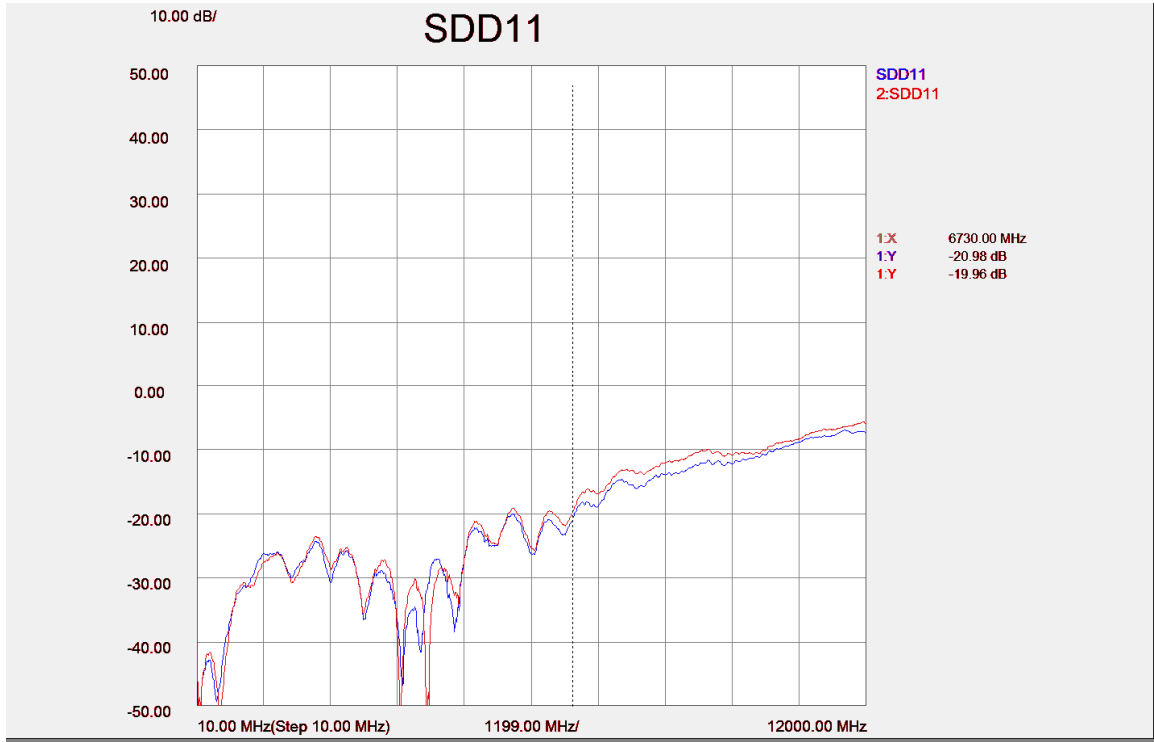

Figure 13. Typical mated pair balanced return loss, with calibration (top) and without calibration (bottom)

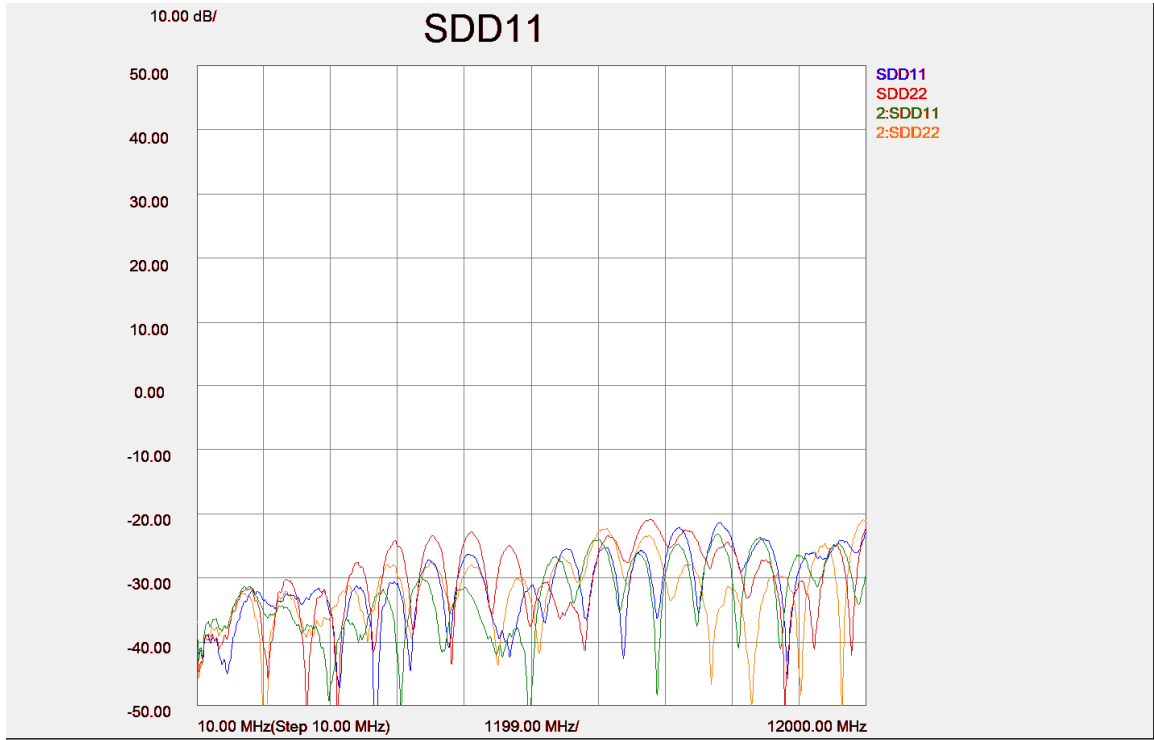

Figure 14. Typical TPA balanced return loss, differential termination replacing connector

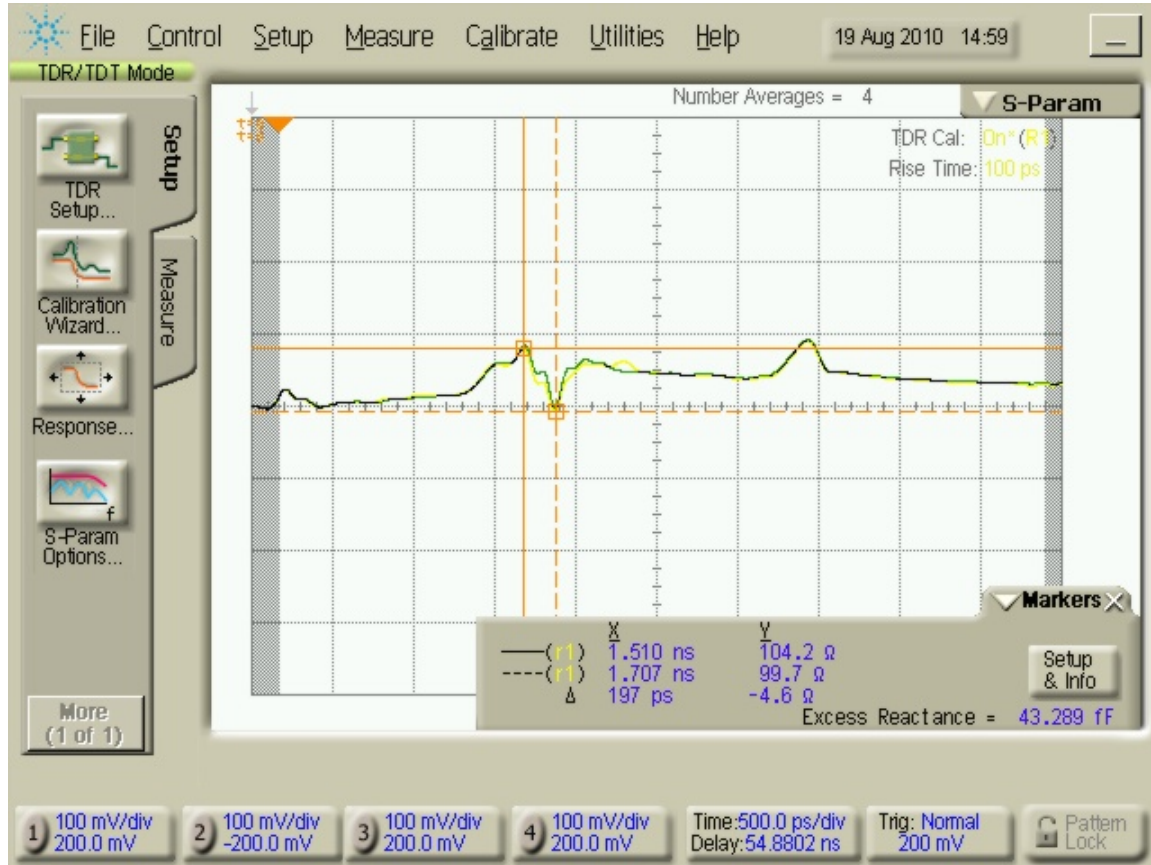

Figure 15. Typical differential TDP of TPA-P connected to TPA-R at 100 ps Rise Time, All differential pairs. (Equivalent to 70ps, 20% to 80%.)

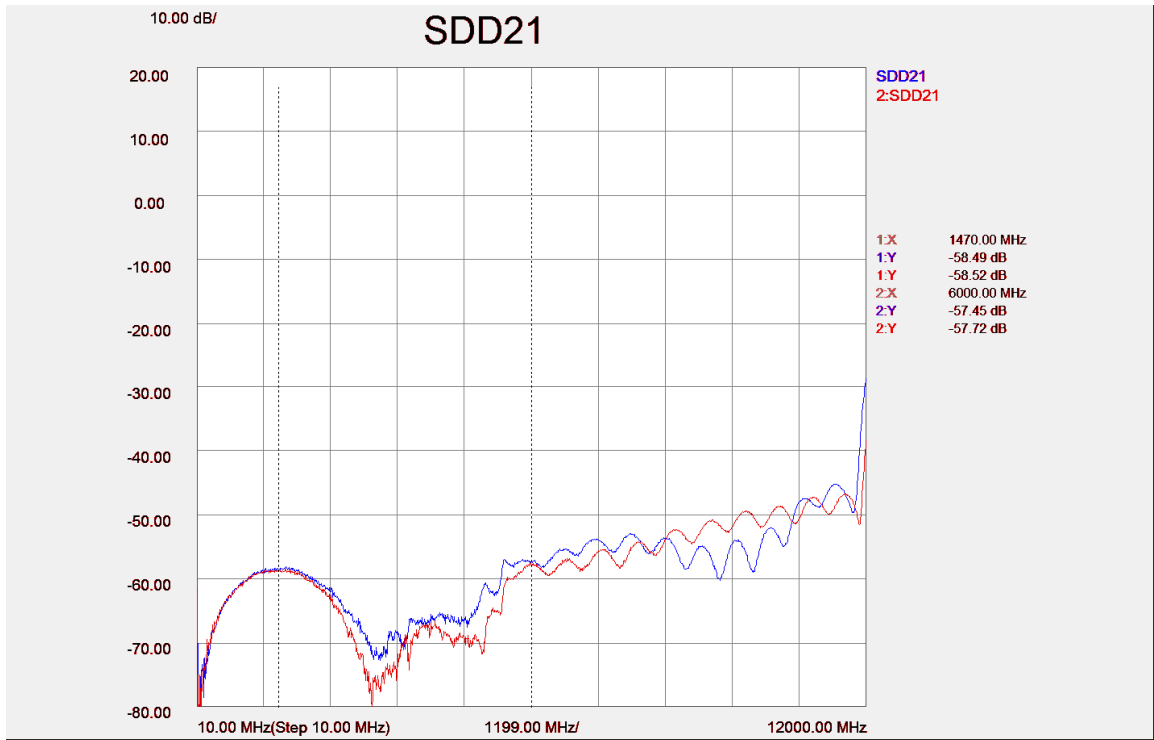
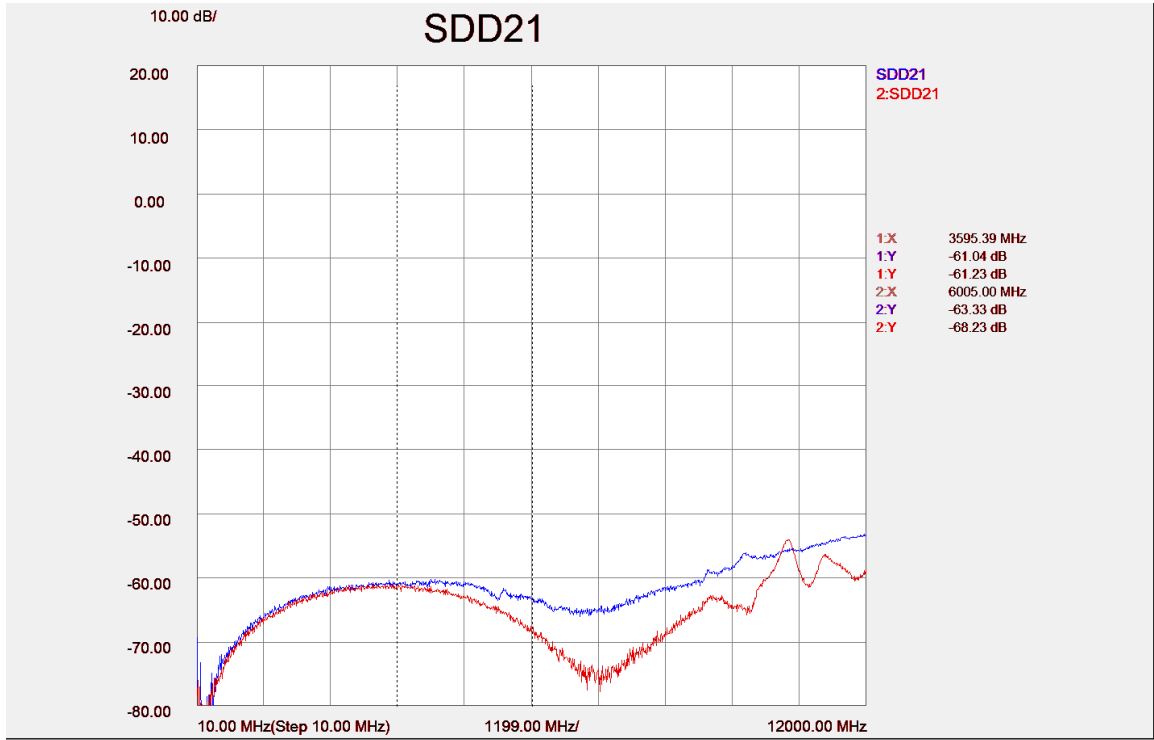

Figure 16. Typical Differential NEXT, without connector (top) and with mated connectors (bottom), adjacent differential pairs, all differential pairs terminated at both ends

Wilder Technologies, LLC – Limited Warranty

Wilder Technologies, LLC warrants that each Test Adapter, 1) is free from defects in materials and workmanship and, 2) conforms to Wilder Technologies specifications for a period of 12 months. **See Consumable and Fragile Material Warranty for exceptions to the 12 month warranty**

The warranty period for a Test Adapter is a specified, fixed period commencing on the date of ship from Wilder Technologies, LLC. If you did not purchase your Test Adapter directly from Wilder Technologies, LLC, the serial number and a valid proof of purchase will be required to establish your purchase date. If you do not have a valid proof of purchase, the warranty period will be measured from the date of ship from Wilder Technologies, LLC.

If, during the warranty period, the Test Adapter is not in good working order, Wilder Technologies, LLC will, at its option, repair or replace it at no additional charge, except as is set forth below. In some cases, the replacement Test Adapter may not be new and may have been previously installed. Regardless of the Test Adapter's production status, Wilder Technologies, LLC appropriate warranty terms apply.

Consumable and Fragile Material Warranty

Wilder Technologies, LLC warrants that consumable materials and all fragile materials supplied by Wilder Technologies, LLC either as part of an instrument or system, or supplied separately, will be free from defects in material and workmanship at the time of shipment.

Extent of Warranty

The warranty does not cover the repair or exchange of a Test Adapter resulting from misuse, accident, modification, unsuitable physical or operating environment, improper maintenance by you, or failure caused by a product for which Wilder Technologies, LLC is not responsible. The warranty is voided by removal or alteration of Test Adapter or parts identification labels. The initial three months are unconditional; the remaining months excludes plugs, receptacles and SMA connectors. Connectors are wear items and excluded from the warranty after the initial three months.

These warranties are your exclusive warranties and replace all other warranties or conditions, express or implied, including but not limited to, the implied warranties or conditions or merchantability and fitness for a particular purpose. These warranties give you specific legal rights and you may also have other rights which vary from jurisdiction to jurisdiction. Some jurisdictions do not allow the exclusion or limitation of express or implied warranties, so the above exclusion or limitation may not apply to you. In that event, such warranties are limited in duration to the warranty period. No warranties apply after that period.

Items Not Covered by Warranty

Wilder Technologies, LLC does not warrant uninterrupted or error-free operation of a Test Adapter.

Any technical or other support provided for a Test Adapter under warranty, such as assistance via telephone with "how-to" questions and those regarding Test Adapter set-up and installation, will be provided **WITHOUT WARRANTIES OF ANY KIND**.

Warranty Service

Warranty service may be obtained from Wilder Technologies, LLC by returning a Wilder Technologies, LLC Returns Material Authorization and the Test Adapter to Wilder Technologies, LLC during the warranty period. To obtain RMA number, contact support@wilder-tech.com.

You may be required to present proof of purchase or other similar proof of warranty entitlement. You are responsible for any associated transportation charges, duties and insurance between you and Wilder Technologies, LLC. In all instances, you must ship Test Adapters in Wilder Technologies, LLC approved packaging. Information on packaging guidelines can be found at: www.wilder-tech.com. Wilder Technologies, LLC will ship repaired or replacement Test Adapter Delivery Duty Prepaid (DDP) and will pay for return shipment. You will receive title to the repaired or replacement Test Adapter and you will be the importer of record.

Wilder Technologies, LLC – Terms & Conditions of Sale

- 1. Other Documents:** This Agreement may NOT be altered, supplemented, or amended by the use of any other document(s) unless otherwise agreed to in a written agreement signed by both you and Wilder Technologies, LLC. If you do not receive an invoice or acknowledgement in the mail, via e-mail, or with your Product, information about your purchase may be obtained at support@wilder-tech.com or by contacting your sales representative.
- 2. Payment Terms, Orders, Quotes, Interest:** Terms of payment are within Wilder Technologies, LLC's sole discretion, and unless otherwise agreed to by Wilder Technologies, LLC, payment must be received by Wilder Technologies, LLC prior to Wilder Technologies, LLC's acceptance of an order. Payment for the products will be made by credit card, wire transfer, or some other prearranged payment method unless credit terms have been agreed to by Wilder Technologies, LLC. Invoices are due and payable within the time period noted on your invoice, measured from the date of the invoice. Wilder Technologies, LLC may invoice parts of an order separately. Your order is subject to cancellation by Wilder Technologies, LLC, in Wilder Technologies, LLC's sole discretion. Unless you and Wilder Technologies, LLC have agreed to a different discount, Wilder Technologies, LLC's standard pricing policy for Wilder Technologies, LLC-branded systems, which includes hardware, software and services in one discounted price, allocates the discount off list price applicable to the service portion of the system to be equal to the overall calculated percentage discount off list price on the entire system. Wilder Technologies, LLC is not responsible for pricing, typographical, or other errors in any offer by Wilder Technologies, LLC and reserves the right to cancel any orders resulting from such errors.
- 3. Shipping Charges; Taxes; Title; Risk of Loss:** Shipping, handling, duties and tariffs are additional unless otherwise expressly indicated at the time of sale. Title to products passes from Wilder Technologies, LLC to Customer on shipment from Wilder Technologies, LLC's facility. Loss or damage that occurs during shipping by a carrier selected by Wilder Technologies, LLC is Wilder Technologies, LLC's responsibility. Loss or damage that occurs during shipping by a carrier selected by you is your responsibility. You must notify Wilder Technologies, LLC within 7 days of the date of your invoice or acknowledgement if you believe any part of your purchase is missing, wrong or damaged. Unless you provide Wilder Technologies, LLC with a valid and correct tax exemption certificate applicable to your purchase of Product and the Product ship-to location, you are responsible for sales and other taxes associated with the order. **Shipping dates are estimates only.**
- 4. WARRANTY:** WILDER TECHNOLOGIES, LLC, warrants that the item(s) manufactured under the Buyer's contract shall be free from defects in materials and workmanship furnished by WILDER TECHNOLOGIES, LLC, and shall conform to the applicable drawings and specifications. WILDER TECHNOLOGIES, LLC'S liability herein, for breach of warranty, contract or negligence in manufacturing, shall be limited to repair or replacement. Repair or replacement of defective items will be applicable only if the Buyer notifies WILDER TECHNOLOGIES, LLC, by written notice within 30-days of delivery. All claims shall be addressed to: support@wilder-tech.com or WILDER TECHNOLOGIES, LLC, 6101A East 18th Street, Vancouver, Washington 98661 U.S.A.; ATTENTION: Customer Service Manager. WILDER TECHNOLOGIES, LLC, reserves the right to inspect at the Buyer's plant all items claimed to be defective or nonconforming prior to authorizing their return. WILDER TECHNOLOGIES, LLC, assumes no liability for the results of the use of its components in conjunction with other electric, electronic or mechanical components, circuits and/or systems. The foregoing constitutes the sole and exclusive remedy of the Buyer and the exclusive liability of WILDER TECHNOLOGIES, LLC, and is IN LIEU OF ANY AND ALL OTHER WARRANTIES, STATUTORY, IMPLIED OR EXPRESSED AS TO MERCHANTABILITY, FITNESS FOR THE PURPOSE SOLD, DESCRIPTION, QUALITY, and PRODUCTIVENESS OR ANY OTHER MATTER. Without limiting the foregoing, in no event shall WILDER TECHNOLOGIES, LLC, be liable for loss of use, profit or other collateral, or for special and/or consequential damages.
- 5. RETURNED GOODS:** WILDER TECHNOLOGIES, LLC, will accept only those goods for return that have been authorized for return. All goods authorized for return shall be assigned a Returned Material Authorization (RMA) Number. The RMA Number shall be clearly marked on the shipping container(s) and all documentation accompanying the goods authorized for return. The RMA Number shall be assigned by WILDER TECHNOLOGIES, LLC pursuant to the conditions set forth in Paragraph 4, WARRANTY.
- 6. UNITED STATES GOVERNMENT CONTRACTS:** In the event this offer is accepted under Government contract, WILDER TECHNOLOGIES, LLC, agrees to accept clauses required by Government regulations and to waive WILDER TECHNOLOGIES, LLC conditions inconsistent therewith. WILDER TECHNOLOGIES, LLC, certifies that it is a regular manufacturer or dealer of the goods and/or services offered herein and that the prices offered do not exceed those charged to any customer for like quantities, services or materials under the same conditions.

Compliance with Environmental Legislation

Wilder Technologies, LLC, is dedicated to complying with the requirements of all applicable environmental legislation and regulations, including appropriate recycling and/or disposal of our products.



WEEE Compliance Statement

The European Union adopted Directive 2002/96/EC on Waste Electrical and Electronic Equipment (WEEE), with requirements that went into effect August 13, 2005. WEEE is intended to reduce the disposal of waste from electrical and electronic equipment by establishing guidelines for prevention, reuse, recycling and recovery.

Wilder Technologies has practices and processes in place to conform to the requirements in this important Directive.

In support of our environmental goals, effective January 1st, 2009 Wilder Technologies, LLC has partnered with E-Tech Recycling of Beaverton, Oregon, www.etechrecycling.com, to recycle our obsolete and electronic waste in accordance with the European Union Directive 2002/96/EC on waste electrical and electronic equipment ("WEEE Directive").

As a service to our customers, Wilder Technologies is also available for managing the proper recycling and/or disposal of all Wilder Technologies products that have reached the end of their useful life. For further information and return instructions, contact support@wilder-tech.com.

Glossary of Terms

TERMINOLOGY	DEFINITION
Aggressor	A signal imposed on a system (i.e., cable assembly) to measure response on other signal carriers.
Decibel (dB)	Ten times the common logarithm (i.e. log10) of the ratio of relative powers.
Informative	The designation of a test that is not required for compliance but is considered important from a characterization standpoint. It is provided for informational purposes only.
Insertion loss	The ratio, expressed in dB, of incident power to delivered power.
mSATA-TPA	mSATA Test Point Access. A specialized assembly that interfaces to an mSATA receptacle or plug and enables access of signals for measurement or stimulation.
Near-end crosstalk	Crosstalk that is propagated in a disturbed channel in the opposite direction as the propagation of a signal in the aggressor channel. The terminals of the aggressor channel and the victim channel are usually close to each other.
Normative	The designation of a test that is required for compliance.
Return Loss	The ratio, expressed in dB, of incident power to reflected power.
SATA Initiator Device	A device containing SSP, STP, and /or SMP initiating ports in a SATA domain.
SATA Link	The SATA link is a full duplex point to point link as continuous data activity exists on each direction. For purposes of compliance testing of Hosts and Devices, the full duplex link is broken into two simplex links, one for the Host transmitting to the Device and the other for the Device transmitting to the Host. Each link is tested for compliance separately.
SATA Target Device	A device containing SSP, STP, and /or SMP target ports in a SATA domain.
Serial ATA (SATA)	The protocol defined by SATA (see ATA8-AAM)
Serial Attached SCSI (SAS)	The set of protocols defined in SPL and the interconnect defined by the SAS-2.1 standard.
Victim	A signal carrier on a system that has a response imposed on it by other signals in the system.

Index

- +1.5V, 3
- +3.3V, 3
- 12-Position Low-Speed Connector, 3, 4, 15
- 1X-THRU, 14
- 22-Position Alternate Connector, 15
- 22-Position SATA plug, 3
- 4-Position Input Power Connector, 3, 4, 15
- Cable Bend Limits, 6
- Cable Losses, 14
- Cable Tension (Pull Forces), 6
- Cable Twisting (Torque), 6
- Calibration, 12
- Care and Handling, 6
- Cleaning, 8
- Compliance
 - WEEE, 33
- Connections
 - mSATA-TPA to DUT, 6
 - SMA, 6, 7
- Crosstalk errors, 13
- de-emphasis, 14
- Directivity errors, 13
- Drift errors, 13
- DUT, 13
- Electrical Specifications, 20
- Electrostatic Discharge Information (ESD), 9
- environmental changes, 13
- Errors
 - Crosstalk*, 13
 - Directivity*, 13
 - drift, 13
 - Load Impedance Mismatching*, 13
 - random, 13
 - Receiver Reflection-tracking in Test Equipment*, 13
 - Receiver Transmission in Test Equipment*, 13
 - Source Impedance Mismatching*, 13
- ESD protection, 9
- Figures
 - Cable Connectors, 15, 18
 - Calibration module, 12
 - The mSATA Test Adapter (Plug), 3
 - The mSATA Test Adapter (Receptacle), 4
- Glossary, 34
- Group delay, 14
- Handling and Storage, 8
- Load Impedance Mismatching errors, 13
- Making Connections, 8
- Mechanical and Environmental Specifications, 15
- Molex Part Numbers, 4
- mSATA Plug TPA Testing a Host, 11
- mSATA Receptacle TPA Testing a mSATA Device, 10
- mSATA-TPA-P Cable Pinout, 18
- mSATA-TPA-R Cable Pinout, 15
- pre-emphasis, 14
- Product Inspection, 5
- product return, 5
- pull force, 6, 7
- Random errors, 13
- Receiver Reflection-tracking in Test Equip. errors, 13
- Receiver Transmission in Test Equipment errors, 13
- SAS Specification 2.1, 10
- SATA Specification 3.0, 3
- secure storage, 5
- SMA cables, 15, 18
- SOLT, 13
- Source Impedance Mismatching errors, 13
- Support, 32
- Supporting Instrument Cables or Accessories, 7
- Tables
 - Electrical Specifications, 20
 - General Specifications, 15
 - mSATA 12-Position Low-Speed Connector, 16
 - mSATA 4-Position Input Power Connector, 16
 - mSATA Alternate Input Power Connector, 16
 - mSATA Plug Pin Assignments, 19
 - mSATA Receptacle Pin Assignments, 17
- Terms and Conditions of Sale, 32
- test instrument noise, 13
- test repeatability problems, 13
- User Model Examples, 10, 11
- Visual Inspection, 8
- Warranty, 31
- Web Sites
 - support@wilder-tech.com, 31, 32
 - www.etechnology.com, 33
 - www.wilder-tech.com, 31
- WEEE, 33

Visit our website at www.wilder-tech.com



Wilder Technologies, LLC
6101A East 18th Street
Vancouver, WA 98661
Phone: 360-859-3041
Fax: 360-859-3105
www.wilder-tech.com

© 2010 Wilder Technologies, LLC
Document No. 910-0008-000 Rev. A
Created: 8/27/2010